

# Data Sheet

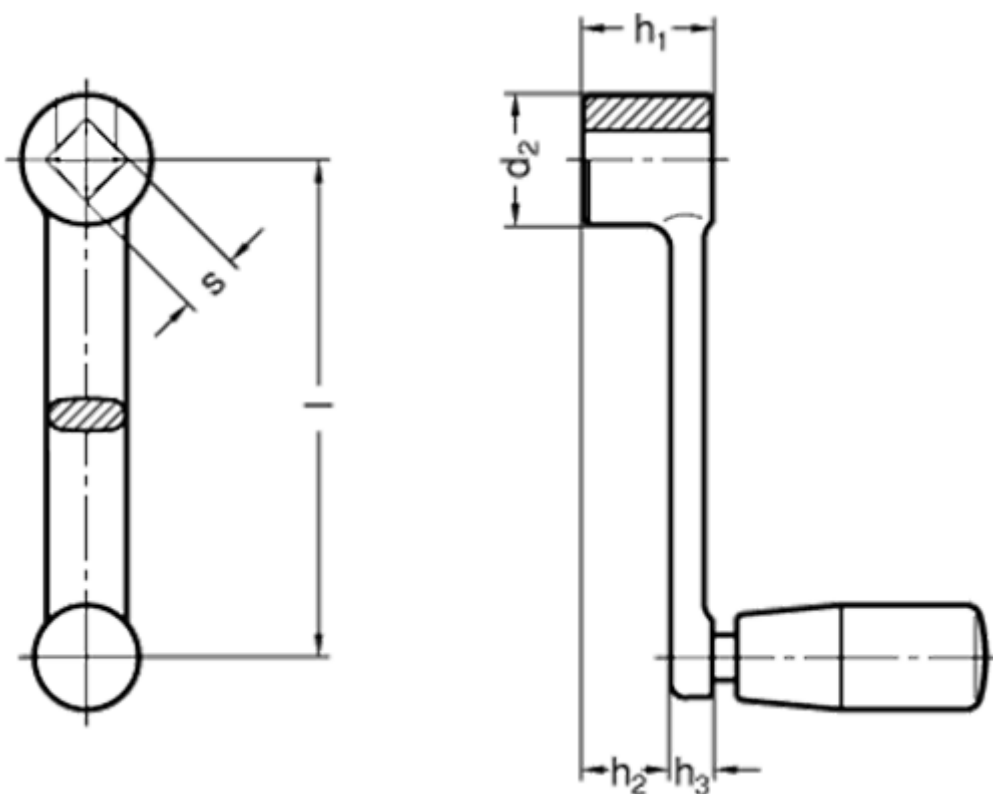

Article number: 201568266  
Description: E+G Crank handle  
GN 269-80-V10

## Measures



d2	= 22
h1	= 22
h2	= 15.4
h3	= 7
Handle	= 18
l	= 80
s	= 10